

**Universal Serial Bus 3.0 Specification Version 1.0
Agilent Method of Implementation (MOI) for USB 3.0
Connectors and Cable Assemblies Compliance Tests
Using Agilent E5071C ENA Option TDR**

Agilent MOI for USB 3.0 Connectors & Cable Assemblies Compliance Tests

Table of Contents

1.	Modification Record.....	5
2.	Instrumentation Requirements.....	6
3.	Outline of the testing	7
4.	Test Port Cable and Fixture Connection.....	8
5.	Description of Measurement Window	10
6.	Perform Measurement Settings	11
6.1.	Recall State File Procedure.....	11
7.	Perform Calibration	12
7.1.	Time Domain Calibration Setup.....	12
7.1.1.	Perform Electronic Calibration (ECal).....	12
7.1.2.	Perform Deskew & Loss Compensation	14
7.1.3.	Set DUT Length.....	18
7.1.4.	Rise Time Adjustment	18
7.2.	Frequency Domain Calibration Setup	21
7.2.1.	Define Calkit	21
7.2.2.	TRL Calibration.....	21
7.3.	Saving Calibration Information	24
7.3.1.	Saving Calibration Information in a State File	24
7.3.2.	Recalling a State File with Calibration Information.....	24
8.	Measurement and Data Analysis	25
8.1.	Connector Impedance, Cable Impedance, Intra-Pair Skew, Insertion Loss, and Mode Conversion	25
8.1.1.	Measurement	25
8.1.2.	Data Analysis.....	26
8.1.3.	Measurement Result Example	27
8.2.	Near End Crosstalk.....	28

Agilent MOI for USB 3.0 Connectors & Cable Assemblies Compliance Tests

8.2.1.	Measurement	28
8.2.2.	Data Analysis.....	28
8.2.3.	Measurement Result Example	29
8.3.	Crosstalk Between D+/D- and Super Speed.....	30
8.3.1.	Measurement	30
8.3.2.	Data Analysis.....	32
8.3.3.	Measurement Result Example	32
8.4.	D+/D- Pair Propagation Delay, D+/D- Pair Intra-Pair Skew and D+/D- Pair Attenuation	33
8.4.1.	Measurement	33
8.4.2.	Data Analysis.....	34
8.4.3.	Measurement Result Example	35
9.	Appendix	36
9.1.	Defining a calibration kit.....	36
9.2.	Time domain Measurement Setup Manually.....	39
9.2.1.	Starting Setup	39
9.2.2.	Mated Connector Impedance Measurements (Normative).....	40
9.2.3.	Raw Cable Impedance Measurements (Informative)	42
9.2.4.	Propagation Delay and Intra-Pair Skew Measurement (Informative)	43
9.2.5.	Differential Near End Crosstalk Measurements (Normative)	45
9.2.6.	Differential Crosstalk between D+/D- and Super Speed Measurements (Normative)	46
9.3.	Frequency Domain Measurement Setup Manually	47
9.3.1.	Channel and Trace Settings	47
9.3.2.	Common Settings	47
9.3.3.	Insertion Loss Measurements (Normative)	47
9.3.4.	Differential-to-Common-Mode Conversion Measurements (Normative).....	48
9.3.5.	D+/D- Pair Attenuation Measurements (Normative)	48

Agilent MOI for USB 3.0 Connectors & Cable Assemblies Compliance Tests

9.4. Limit Settings	49
9.4.1. Displaying Judgment Result of Test	49
9.4.2. Setting the Warning Beeper	49
9.4.3. Defining the Limit Line.....	49

Agilent MOI for USB 3.0 Connectors & Cable Assemblies Compliance Tests

1. Modification Record

Revision	Comments	Issue Date
2.3	- Modified the limit value of D+/D- Pair Propagation Delay.	Dec 17, 2012
2.2	- Instrumentation Requirements are revised. - Calibration method is revised for the time domain.	Dec 16, 2010
2.1	- Calibration method is revised for the time domain.	Nov 15, 2010
2.0	- The Option TDR is supported.	Sep 7, 2010
1.1	- Added the Near End Crosstalk for Time Domain. - Added the 4-Port ECal and De-Embedding. - Modified the test limit for the Near End Crosstalk and Far End Crosstalk.	Dec 15, 2009
1.0	Draft.	Jun 16, 2009

2. Instrumentation Requirements

1. E5071C ENA Series Network Analyzer (Must include option TDR and one of the following options 480/485/4D5/4K5. Option 4D5 or 4K5 is recommended for more bandwidth and higher resolution)
2. USB 3.0 official test fixtures and calibration standards, or an equivalent set of fixtures and standards¹.

List of calibration standards

- Short
- Thru
- 1/2 Thru
- Line 1, Line 2, Line 3

Note: For more information, refer to Defining a calibration kit in 9.1.

3. Four 3.5mm(f)-Type N(m) adapters (Agilent 1250-1744) for E5071C with option 480/485 or four 83059B coaxial adapter for E5071C with option 4D5/4K5
4. Four 3.5 mm quality cables (male to male) of 10 GHz bandwidth or more.
5. One of the following calibration kits to calibrate 3.5 mm cables.
 - N4431B-010 Electronic Calibration (ECal) Module or 85033E-100 Standard Mechanical Calibration Kit for E5071C with option 480/485
 - N4433A-010 Electronic Calibration (ECal) Module or 85052D Economy Mechanical Calibration Kit for E5071C with option 4DK/4K5
6. 50 ohm terminations to terminate unused channels (ex. Agilent 909D-301)

Reference Documents

1. Universal Serial Bus 3.0 Specification.
2. Universal Serial Bus 3.0 Connectors and Cable Assemblies Compliance Document.

¹ For official fixtures and standards, please contact BitifEye.

3. Outline of the testing

- 1. Set measurement conditions.**
- 2. Connect matched 3.5 mm cables to the test ports of the instrument.**
- 3. For Time Domain Measurements, perform Electronic Calibration (ECal) or Deskew & Loss Compensation and adjust the rise time on each trace.**
- 4. For Frequency Domain Measurements, perform TRL calibration at the 3.5 mm cables for all ports.**
- 5. Perform Time Domain Measurements**
 - Mated Connector Impedance measurements (Normative).
 - Raw Cable Impedance measurements (Informative).
 - Intra-Pair Skew measurements (Informative).
 - D+/D- Pair Intra-Pair Skew measurements (USB 2.0).
 - D+/D- Pair Propagation Delay measurements (USB 2.0).
 - Differential Near End Crosstalk measurements (Normative).
 - Differential Crosstalk Between D+/D- and Super Speed measurements (Normative).
- 6. Perform Frequency Domain Measurements**
 - Insertion Loss measurements (Normative).
 - Differential-to-Common-Mode Conversion measurements (Normative).
 - D+/D- Pair Attenuation measurements (USB 2.0).

*Note: Hard Keys (Keys located on the Front panel of E5071C) are displayed in **Blue color and Bold**. (Example: **Avg, Analysis**)*

*Note: Soft keys (Keys on the screen) are displayed in **Bold**. (Example: **S11, Real, Transform**)*

*Note: Buttons (in the TDR) are displayed in **Green color and Bold**. (Example: **Trace, Rise Time**)*

*Note: Tabs (in the TDR) are displayed in **Brown color and Bold**. (Example: **Setup, Trace Control**)*

4. Test Port Cable and Fixture Connection

Cable under test will be tested in the following manner

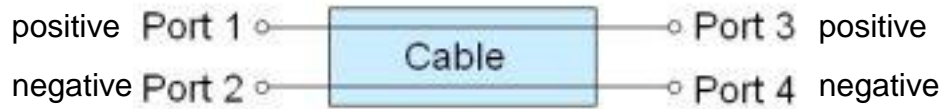

Example: Testing Insertion Loss.

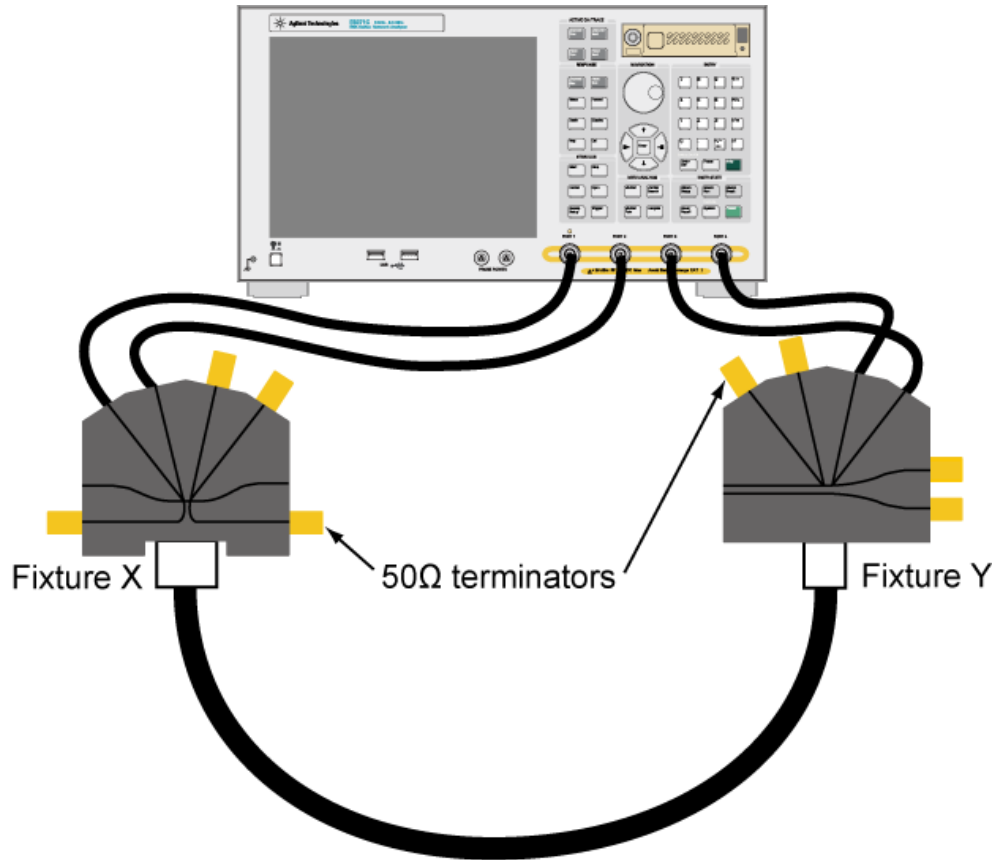

Agilent MOI for USB 3.0 Connectors & Cable Assemblies Compliance Tests

Table 4-1 Connection by connector type

Connector Type		Standard-A(X) to Standard-B(Y)				Standard-A(X) to Micro-AB(Y)				Standard-A(X) to Standard-A(Y)			
		1	2	3	4	1	2	3	4	1	2	3	4
ENA Port #													
Fixture PIN Number	Connector Imp.	X8	X9	Y8	Y9	X8	X9	Y9	Y10	X8	X9	Y5	Y6
	Cable Imp.	Y5	Y6	X5	X6	Y6	Y7	X5	X6	Y8	Y9	X5	X6
	Intra-Pair Skew												
	Insertion Loss												
	Mode Conversion												
	Near End Crosstalk	X8	X9	X5	X6	X8	X9	X5	X6	X8	X9	X5	X6
		Y5	Y6	Y8	Y9	Y6	Y7	Y9	Y10	Y8	Y9	Y5	Y6
	D+/D- and SS Crosstalk	X2	X3	X5	X6	X2	X3	X5	X6	X2	X3	X5	X6
		X2	X3	X8	X9	X2	X3	X8	X9	X2	X3	X8	X9
		X2	X3	Y5	Y6	X2	X3	Y6	Y7	X2	X3	Y5	Y6
	X2	X3	Y8	Y9	X2	X3	Y9	Y10	X2	X3	Y8	Y9	
	X5	X6	Y2	Y3	X5	X6	Y2	Y3	X5	X6	Y2	Y3	
	X8	X9	Y2	Y3	X8	X9	Y2	Y3	X8	X9	Y2	Y3	
	Y5	Y6	Y2	Y3	Y6	Y7	Y2	Y3	Y5	Y6	Y2	Y3	
	Y8	Y9	Y2	Y3	Y9	Y10	Y2	Y3	Y8	Y9	Y2	Y3	
D+/D- Propagation Delay	X2	X3	Y2	Y3	X2	X3	Y2	Y3	X2	X3	Y2	Y3	
D+/D- Intra-Pair Skew													
D+/D- Attenuation													

Connector Type		Micro-AB(X) to Micro-AB(Y)				Micro-AB(X) to Standard-B(Y)			
		1	2	3	4	1	2	3	4
ENA Port #									
Fixture PIN Number	Connector Imp.	X6	X7	Y9	Y10	X6	X7	Y8	Y9
	Cable Imp.	Y6	Y7	X9	X10	Y5	Y6	X9	X10
	Intra-Pair Skew								
	Insertion Loss								
	Mode Conversion								
	Near End Crosstalk	X6	X7	X9	X10	X6	X7	X9	X10
		Y6	Y7	Y9	Y10	Y5	Y6	Y8	Y9
	D+/D- & and Crosstalk	X2	X3	X6	X7	X2	X3	X6	X7
		X2	X3	X9	X10	X2	X3	X9	X10
		X2	X3	Y6	Y7	X2	X3	Y5	Y6
	X2	X3	Y9	Y10	X2	X3	Y8	Y9	
	X6	X7	Y2	Y3	X6	X7	Y2	Y3	
	X9	X10	Y2	Y3	X9	X10	Y2	Y3	
	Y6	Y7	Y2	Y3	Y5	Y6	Y2	Y3	
	Y9	Y10	Y2	Y3	Y8	Y9	Y2	Y3	
D+/D- Propagation Delay	X2	X3	Y2	Y3	X2	X3	Y2	Y3	
D+/D- Intra-Pair Skew									
D+/D- Attenuation									

5. Description of Measurement Window

The following figure is the description of the measurement window.

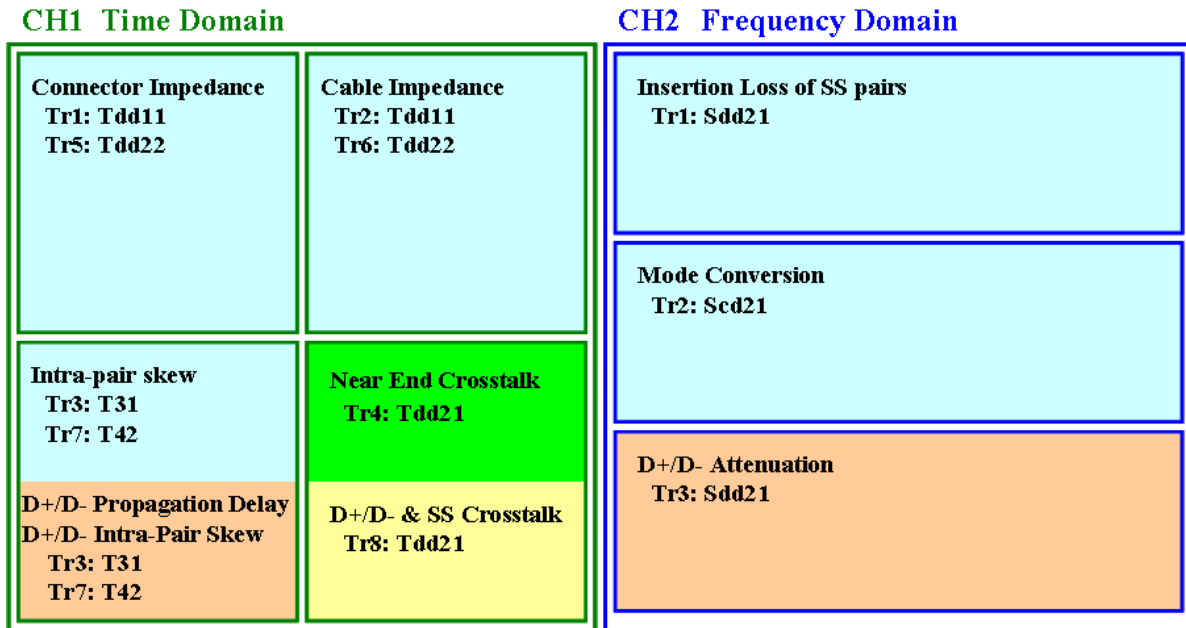

The following figure is the actual measurement example.

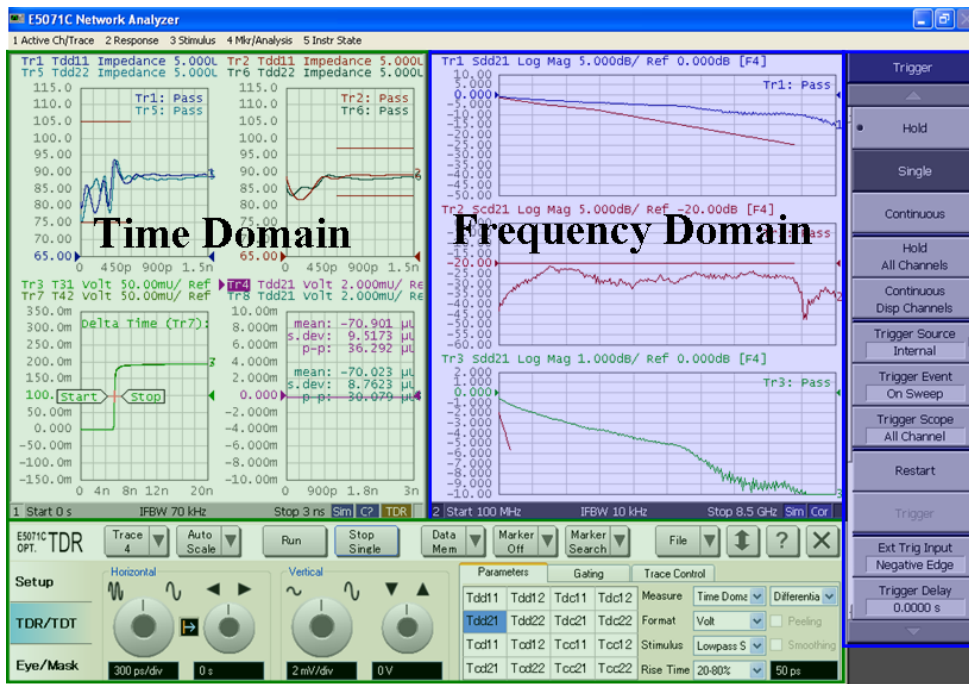

6. Perform Measurement Settings

This section describes how to recall a state file for Time Domain and Frequency Domain settings. A state file can be downloaded from the following URL.

http://www.agilent.com/find/ena-tdr_usb3-cabcon

If you use your local PC to download, save the state file to a USB mass storage device in order to move it to E5071C. Connect the USB mass storage device into the front USB port of the E5071C.

For manual measurement settings, refer to 9.2 Time domain Measurement Setup Manually and 9.3 Frequency Domain Measurement Setup Manually.

6.1. Recall State File Procedure

1. If TDR setup wizard appears, click **Close** button in the TDR setup wizard.
2. Click **Setup** tab (item 1).
3. Click **Advanced Mode** (item 2).

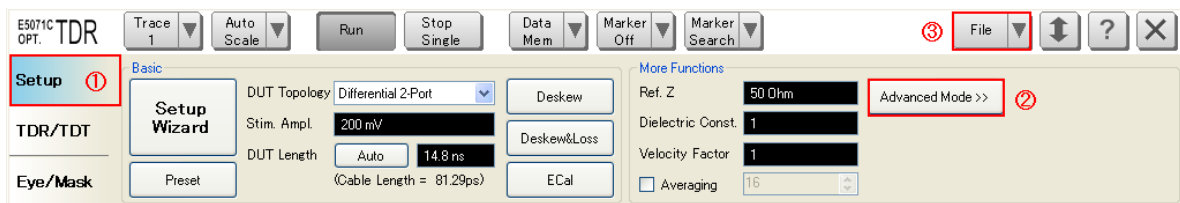

4. A dialog box appears requesting for confirmation. Then click **Yes**. (Clear the check box for “Use Advanced Calibration Methods”)

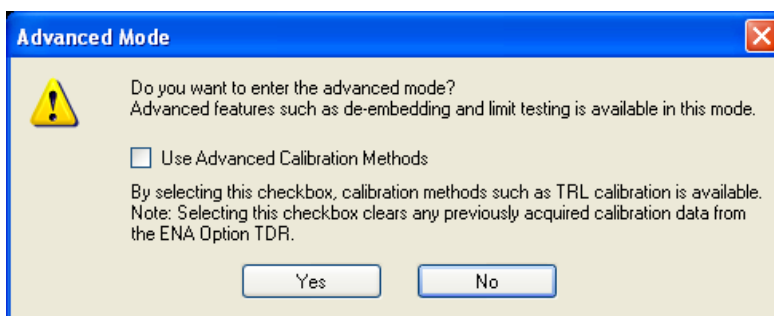

5. Click **File** (item 3) and Select **Recall State** to open the Recall State dialog box.
6. Specify the folder and click **Open**.

7. Perform Calibration

7.1. Time Domain Calibration Setup

There are two ways to perform Time Domain calibration. Please select to perform Electronic Calibration (ECal) in 7.1.1 or Deskew & Loss Compensation in 7.1.2.

7.1.1. Perform Electronic Calibration (ECal)

1. Click **Setup** tab (item 1).



2. Click **ECal** (item 2) to launch the setup wizard.

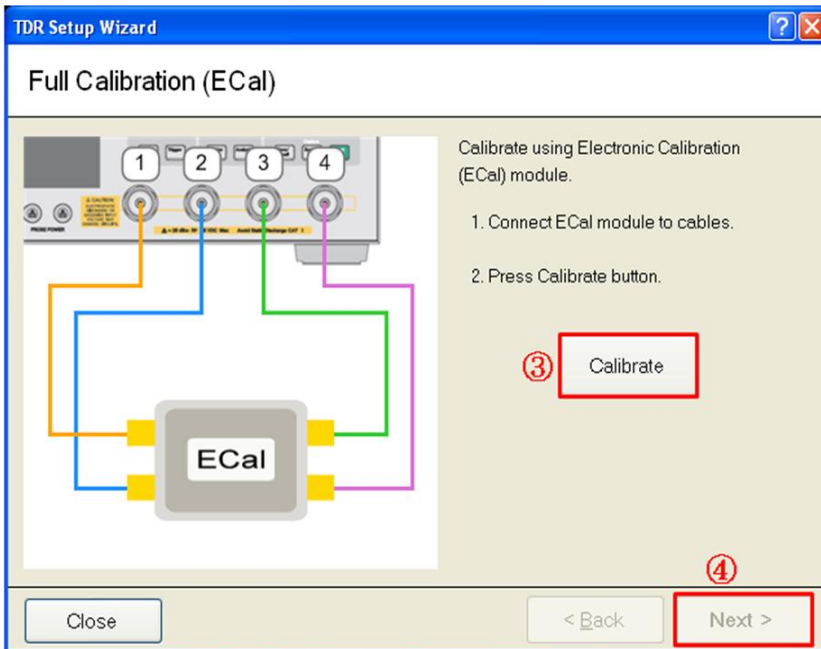

3. Connect 3.5 mm cables to ECal module and click **Calibrate** (item 3). When ECal is completed and the check-mark appears, click **Next** (item 4).

Agilent MOI for USB 3.0 Connectors & Cable Assemblies Compliance Tests

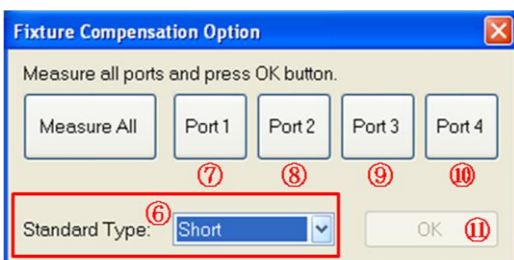
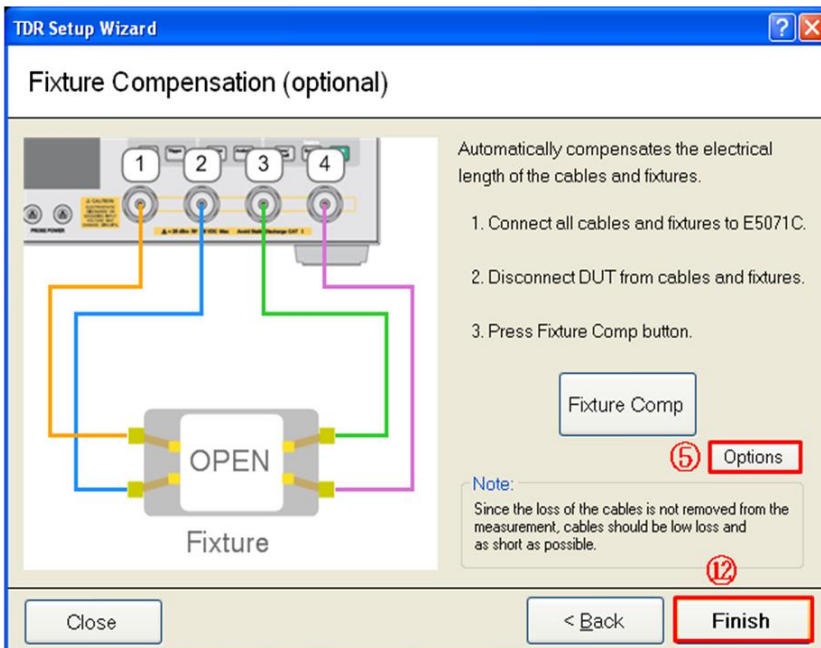

4. Click **Option** (item 5), then Fixture Compensation Option dialog box appears.
5. Select **Standard Type** (item 6) to Short
6. Connect “Short” standard from USB 3.0 official test fixtures to Port 1.
7. Click **Port 1** (item 7). Wait until the check-mark appears under Port 1.
8. Connect “Short” standard from USB 3.0 official test fixtures to Port 2.
9. Click **Port 2** (item 8). Wait until the check-mark appears under Port 2.
10. Connect “Short” standard from USB 3.0 official test fixtures to Port 3.
11. Click **Port 3** (item 9). Wait until the check-mark appears under Port 3.
12. Connect “Short” standard from USB 3.0 official test fixtures to Port 4.
13. Click **Port 4** (item 10). Wait until the check-mark appears under Port 4.
14. Click **OK** (item 11).
15. Click **Finish** (item 12).

Agilent MOI for USB 3.0 Connectors & Cable Assemblies Compliance Tests

16. Proceed to 7.1.3 Set DUT Length followed by 7.1.4 Rise Time Adjustment.

7.1.2. Perform Deskew & Loss Compensation

1. Click **Setup** tab (item 1).



2. Click **Deskew & Loss** (item 2) to launch the setup wizard.

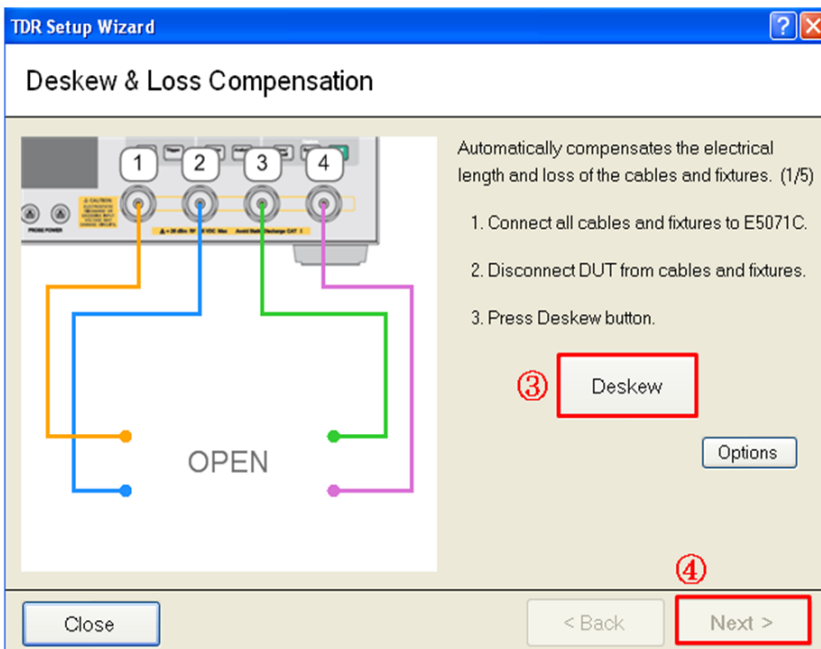

3. Leave the 3.5 mm cables “Open” as illustrated above and click **Deskew** (item 3).
When Deskew is completed and the check-mark appears, click **Next** (item 4).

Agilent MOI for USB 3.0 Connectors & Cable Assemblies Compliance Tests

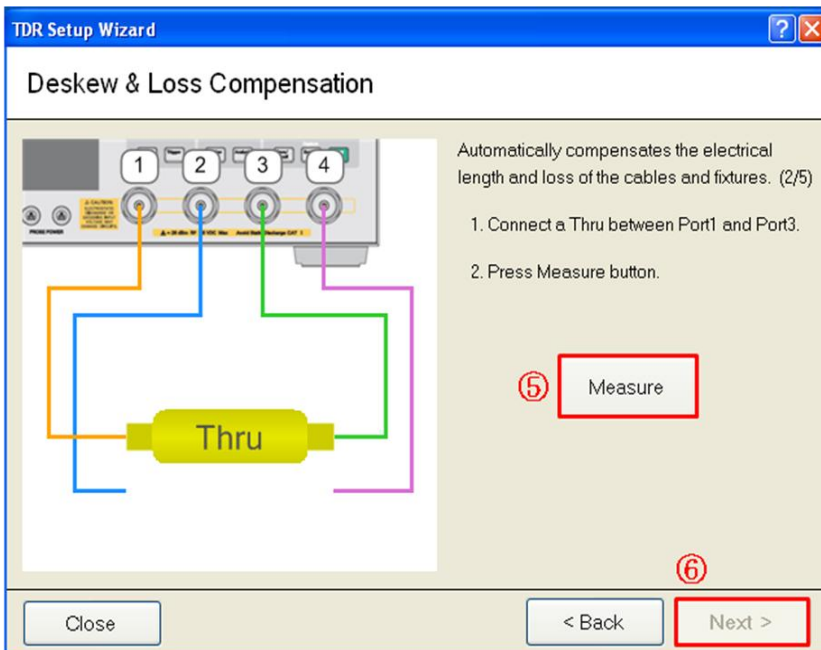

4. Connect 3.5 mm(f) to 3.5mm(f) adapter of 85033E or 85052D Mechanical Calibration Kit between 3.5 mm cables from Port 1 and Port 3 as illustrated above.
5. Click **Measure** (item 5). When the check-mark appears, click **Next** (item 6).

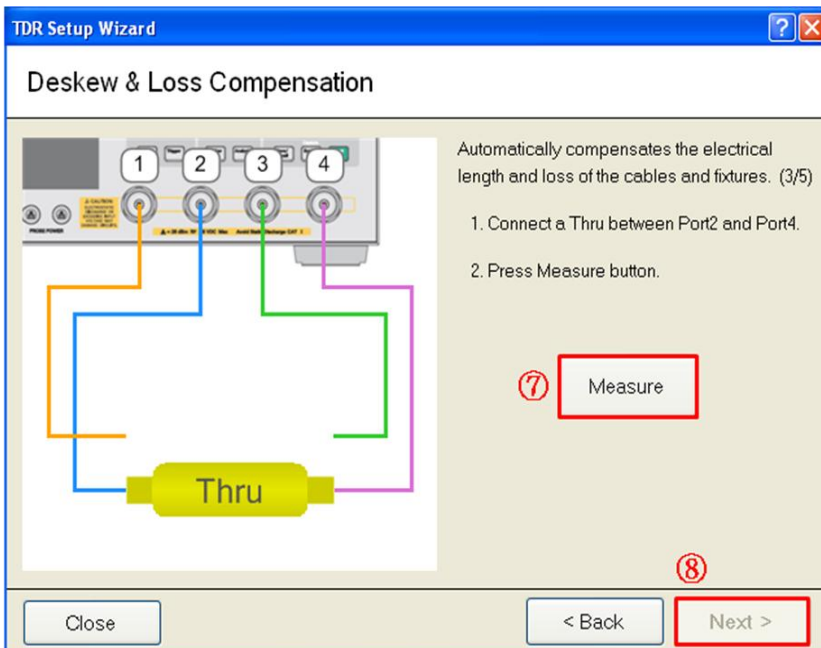

6. Connect 3.5 mm(f) to 3.5mm(f) adapter of 85033E or 85052D Mechanical Calibration Kit between 3.5 mm cables from Port 2 and Port 4 as illustrated above.

Agilent MOI for USB 3.0 Connectors & Cable Assemblies Compliance Tests

- Click **Measure** (item 7). When the check-mark appears, click **Next** (item 8).

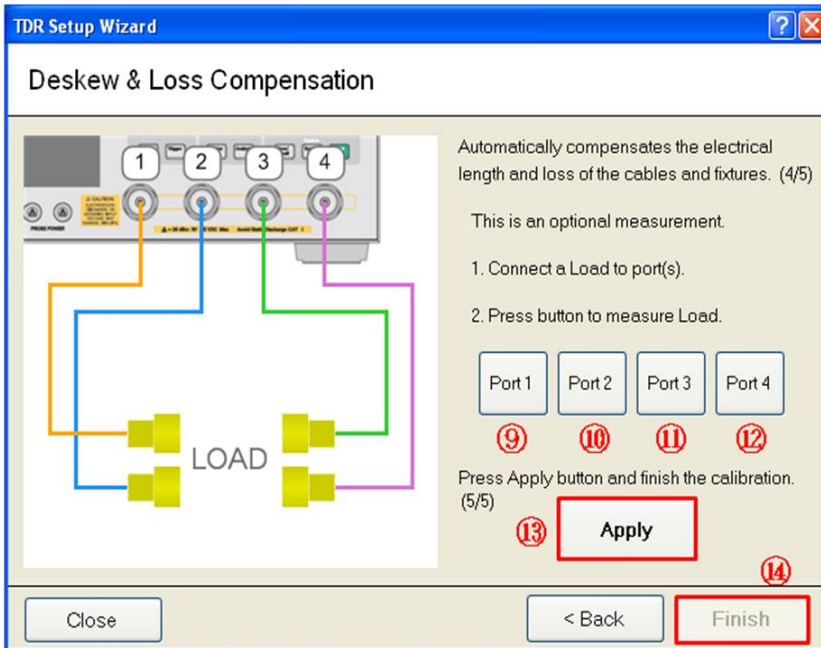

- Connect “Load” standard of 85033E or 85052D Mechanical Calibration Kit to the 3.5 mm cable from Port 1.
- Click **Port 1** (item 9). Wait until the check-mark appears under Port 1.
- Connect “Load” standard of 85033E or 85052D Mechanical Calibration Kit to the 3.5 mm cable from Port 2.
- Click **Port 2** (item 10). Wait until the check-mark appears under Port 2.
- Connect “Load” standard of 85033E or 85052D Mechanical Calibration Kit to the 3.5 mm cable from Port 3.
- Click **Port 3** (item 11). Wait until the check-mark appears under Port 3.
- Connect “Load” standard of 85033E or 85052D Mechanical Calibration Kit to the 3.5 mm cable from Port 4.
- Click **Port 4** (item 12). Wait until the check-mark appears under Port 4.
- Click **Apply** (item 13).
- Click **Finish** (item 14).
- Press **Cal** key on the instrument front panel.

Agilent MOI for USB 3.0 Connectors & Cable Assemblies Compliance Tests

19. Click **Port Extensions**.
20. Click **Auto Port Extension**.
21. Click **Select Ports**.
22. Make sure check-marks are on all the ports. If there are ports without check-marks, click on the ports to activate them.
23. Click **Return**.
24. Click **Measure SHORT**.
25. Connect “Short” standard of USB 3.0 official test fixtures to the 3.5 mm cable from Port 1.
26. Click **Port 1**. Wait until the check-mark appears.
27. Connect “Short” standard of USB 3.0 official test fixtures to the 3.5 mm cable from Port 2.
28. Click **Port 2**. Wait until the check-mark appears.
29. Connect “Short” standard of USB 3.0 official test fixtures to the 3.5 mm cable from Port 3.
30. Click **Port 3**. Wait until the check-mark appears.
31. Connect “Short” standard of USB 3.0 official test fixtures to the 3.5 mm cable from Port 4.
32. Click **Port 4**. Wait until the check-mark appears.
33. Click **Return**.
34. Click **Return**.
35. Click **Return**.
36. Proceed to 7.1.3 Set DUT Length followed by 7.1.4 Rise Time Adjustment.

Agilent MOI for USB 3.0 Connectors & Cable Assemblies Compliance Tests

7.1.3. Set DUT Length

1. Set DUT length to 16 ns (item 1).

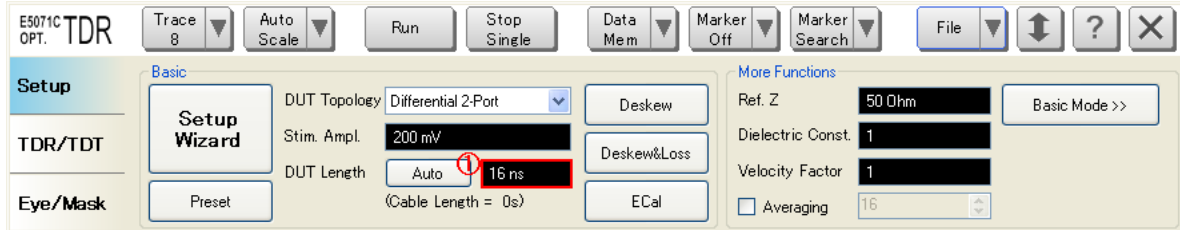

7.1.4. Rise Time Adjustment

1. Connect “1/2 Thru” standard of USB 3.0 official test fixtures to 3.5 mm cable from Port 1.

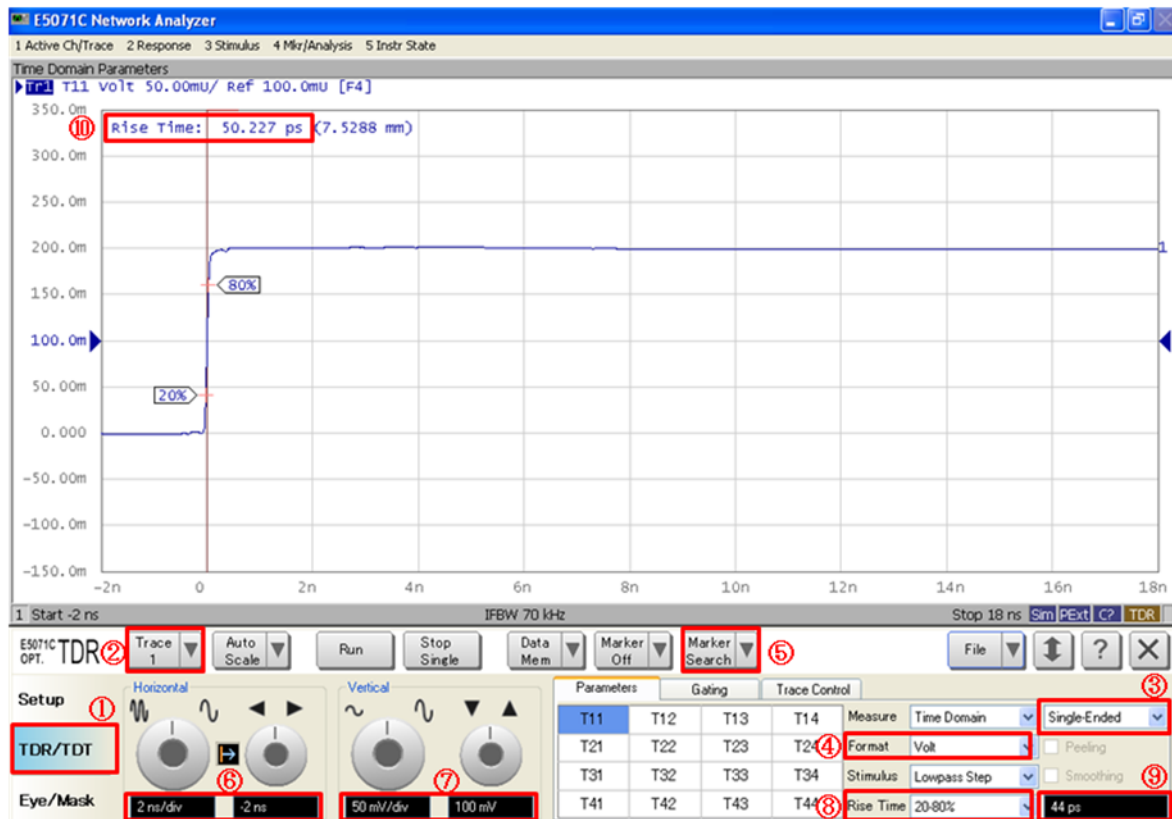

2. Click **TDR/TDT** tab (item 1).
3. Select **Trace 1** (item 2).
4. Press **Channel Max** key on the instrument front panel to enlarge the channel.

Agilent MOI for USB 3.0 Connectors & Cable Assemblies Compliance Tests

5. Press **Trace Max** key on the instrument front panel to enlarge the trace.
6. Set **Measure** (item 3) to “Single-Ended”.
7. Set **Format** (item 4) to “Volt”.
8. Click **Marker Search** (item 5) and select Rise Time (20-80%).
9. Set **Horizontal** (item 6) to 2 ns/div and -2 ns.
10. Set **Vertical** (item 7) to 50 mV/div and 100 mV.
11. Adjust **Rise Time** (item 9) until the measured rise time (item 10) is as close as to 50 ps.
12. Record the value at **Rise Time** (item 9) as the effective rise time for Mated Connector Impedance and Differential Near End Crosstalk measurements.
13. Click **Marker Search** (item 5) and select Rise Time (10-90%).
14. Change **Rise Time** (item 8) to “10-90%”.
15. Adjust **Rise Time** (item 9) until the measured rise time (item 10) is as close as to 200 ps.
16. Record the value at **Rise Time** (item 9) as the effective rise time for Raw Cable Impedance, Intra-Pair Skew, and Propagation Delay measurements.
17. Adjust **Rise Time** (item 9) until the measured rise time (item 10) is as close as to 500 ps.
18. Record the value at **Rise Time** (item 9) as the effective rise time for Differential Crosstalk between D+/D- and Super Speed measurement.
19. Set **Rise Time** (item 8) to “20-80%”.
20. Set **Rise Time** (item 9) back to the recorded value in step 12.
21. Set **Measure** (item 3) to “Differential”.
22. Set **Format** (item 4) to “Impedance”.
23. Click **Marker Search** (item 5) and disable the rise time marker.
24. Set **Horizontal** (item 6) to 150 ps/div and 0 ns.
25. Set **Vertical** (item 7) to 5 Ohm/div and 65 Ohm.
26. Select **Trace 5** (item 2).
27. Set **Rise Time** (item 9) to the recorded value in step 12.

Agilent MOI for USB 3.0 Connectors & Cable Assemblies Compliance Tests

28. Select **Trace 4** (item 2).
29. Set **Rise Time** (item 9) to the recorded value in step 12.
30. Select **Trace 2** (item 2).
31. Set **Rise Time** (item 9) to the recorded value in step 16.
32. Select **Trace 6** (item 2).
33. Set **Rise Time** (item 9) to the recorded value in step 16.
34. Select **Trace 3** (item 2).
35. Set **Rise Time** (item 9) to the recorded value in step 16.
36. Select **Trace 7** (item 2).
37. Set **Rise Time** (item 9) to the recorded value in step 16.
38. Select **Trace 8** (item 2).
39. Set **Rise Time** (item 9) to the recorded value in step 18.
40. Press **Trace Max** key on the instrument front panel to shrink the trace.
41. Press **Channel Max** key on the instrument front panel to shrink the channel.

Agilent MOI for USB 3.0 Connectors & Cable Assemblies Compliance Tests

7.2. Frequency Domain Calibration Setup

7.2.1. Define Calkit

7.2.1.1. Importing Definition File of Calibration Kit

The calkit definition file of the USB 3.0 official test fixtures and calibration standards can be downloaded from http://www.agilent.com/find/ena-tdr_usb3-cabcon.

For manually defining calkit definition, refer to 9.1 Defining a calibration kit.

1. Press **Cal** key on the instrument front panel.
2. Click **Cal kit**, then select **User**.
3. Click **Modify Cal Kit > Import Cal Kit...** to open the dialog box.
4. Specify the folder and click **Open**.

7.2.2. TRL Calibration

1. Press **Channel Next** key on the instrument front panel to select channel 2.
2. Press **Cal** key on the instrument front panel.
3. Click **Calkit** and select the calkit definition file.
4. Click **Calibrate > 4-Port TRL Cal**.
5. Click **Thru/Line**.
 - a) Connect “Thru” standard of USB 3.0 official test fixtures between 3.5 mm cables from Port 1 and Port 2.
 - b) Click **1-2 Thru/Line**.
 - c) Connect “Thru” standard of USB 3.0 official test fixtures between 3.5 mm cables from Port 1 and Port 3.
 - d) Click **1-3 Thru/Line**.
 - e) Connect “Thru” standard of USB 3.0 official test fixtures between 3.5 mm cables from Port 3 and Port 4.
 - f) Click **3-4 Thru/Line**.
 - g) Click **Return**.

Agilent MOI for USB 3.0 Connectors & Cable Assemblies Compliance Tests

6. Click **Reflect**.
 - a) Connect “Short” standard of USB 3.0 official test fixtures to 3.5 mm cable from Port 1.
 - b) Click **Port1 Reflect**.
 - c) Connect “Short” standard of USB 3.0 official test fixtures to 3.5 mm cable from Port 2.
 - d) Click **Port2 Reflect**.
 - e) Connect “Short” standard of USB 3.0 official test fixtures to 3.5 mm cable from Port 3.
 - f) Click **Port3 Reflect**.
 - g) Connect “Short” standard of USB 3.0 official test fixtures to 3.5 mm cable from Port 4.
 - h) Click **Port4 Reflect**.
 - i) Click **Return**.
7. Click **Line/Match**
 - a) Click **1-2 Line/Match**.
 - b) Connect “Line 1” standard of USB 3.0 official test fixtures between 3.5 mm cables from Port 1 and Port 2.
 - c) Click **Line/Match 1[Line1]**.
 - d) Connect “Line 2” standard of USB 3.0 official test fixtures between 3.5 mm cables from Port 1 and Port 2.
 - e) Click **Line/Match 2[Line2]**.
 - f) Connect “Line 3” standard of USB 3.0 official test fixtures between 3.5 mm cables from Port 1 and Port 2.
 - g) Click **Line/Match 3[Line3]**.
 - h) Click **Return**.
 - i) Click **1-3 Line/Match** and repeat step b) to h).
 - j) Click **3-4 Line/Match** and repeat step b) to h).

Agilent MOI for USB 3.0 Connectors & Cable Assemblies Compliance Tests

- k) Click **Return**.
- 8. Click **Done** to finish TRL 4-port calibration. At this point, the calibration coefficient is calculated and saved. The error correction function is automatically turned on.

Note: Refer to “4-port TRL Calibration” in ENA online help for the detail.

Agilent MOI for USB 3.0 Connectors & Cable Assemblies Compliance Tests

7.3. Saving Calibration Information

Calibration information can be saved in a state file and recalled again. Calibration information is effective only when there has no change in measurement conditions before saving the state file and after recalling it. Changes in measurement conditions can be disconnect of 3.5 mm cables, bending 3.5mm cables, use of different 3.5 mm cables, different fixtures, change in temperature, etc.

7.3.1. Saving Calibration Information in a State File

1. Press **Save/Recall** key on the instrument front panel.
2. Click **Save Type**.
3. Change save type to “State & Cal”.

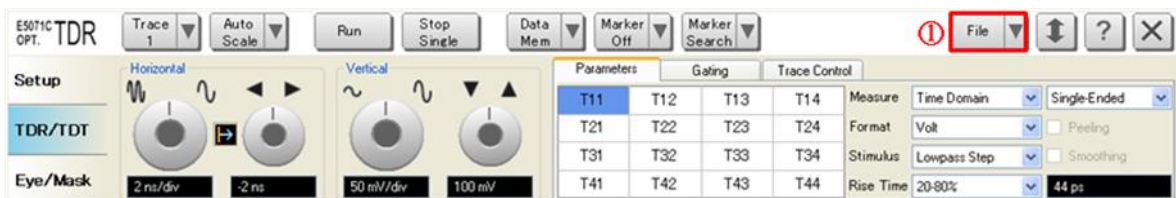

4. Click **File** (item 1).
5. Select “Save State”.
6. Enter file name and save the state file with calibration information.

7.3.2. Recalling a State File with Calibration Information

Refer to 6.1 Recall State File Procedure.

Note: When using calibration information in the state file, it is recommended to measure a device with known characteristics to verify calibration effectiveness before performing actual measurements.

8. Measurement and Data Analysis

8.1. Connector Impedance, Cable Impedance, Intra-Pair Skew, Insertion Loss, and Mode Conversion

8.1.1. Measurement

1. Press **Channel Next** key on the instrument front panel to select channel 1.
2. Connect USB 3.0 official test fixtures to the test port cables according to the Table 8-1 Connector Impedance, Cable Impedance Intra-Pair Skew, Insertion Loss, and Mode Conversion Connection. Unused terminals should be terminated.
3. Connect an USB 3.0 cable to the test fixtures.
4. Click **Stop Single** for Time Domain measurements.
5. Press **Trigger > Single** for Frequency Domain measurements.

Table 8-1 Connector Impedance, Cable Impedance Intra-Pair Skew, Insertion Loss, and Mode Conversion Connection

	Standard-A to Standard-B				Standard-A to Micro-AB				Standard-A to Standard-A			
ENA Port#	Port1	Port2	Port3	Port4	Port1	Port2	Port3	Port4	Port1	Port2	Port3	Port4
PIN #	X8	X9	Y8	Y9	X8	X9	Y9	Y10	X8	X9	Y5	Y6
	Y5	Y6	X5	X6	Y6	Y7	X5	X6	Y8	Y9	X5	X6
	Micro-AB to Micro-AB				Micro-AB to Standard-B							
ENA Port#	Port1	Port2	Port3	Port4	Port1	Port2	Port3	Port4				
PIN #	X6	X7	Y9	Y10	X6	X7	Y8	Y9				
	Y6	Y7	X9	X10	Y5	Y6	X9	X10				

Agilent MOI for USB 3.0 Connectors & Cable Assemblies Compliance Tests

8.1.2. Data Analysis

For Pass/Fail refer to below.

8.1.2.1. Mated Connector Impedance Limit

Limit	Start Time	End Time	Start Limit	End Limit
Upper	0 s	600 ps	105 U	105 U
Lower	0 s	600 ps	75 U	75 U

“U”: impedance unit.

8.1.2.2. Raw Cable Impedance Limit

Limit	Start Time	End Time	Start Limit	End Limit
Upper	600 ps	1.5 ns	97 U	97 U
Lower	600 ps	1.5 ns	83 U	83 U

“U”: Impedance unit

8.1.2.3. Intra-Pair Skew Limit

1. Select **Trace 3**.
2. Press **Trace Max** key on the instrument front panel to enlarge the trace.
3. Read the Delta Time.
4. Press **Trace Max** key on the instrument front panel to shrink the trace.

If Delta Time < 15 psec/m: Pass, else: Fail.

8.1.2.4. Insertion Loss Limit

Start Frequency	End Frequency	Start Limit	End Limit
100 MHz	1.25 GHz	-1.5 dB	-5 dB
1.25 GHz	2.5 GHz	-5 dB	-7.5 dB
2.5 GHz	7.5 GHz	-7.5 dB	-25 dB

Agilent MOI for USB 3.0 Connectors & Cable Assemblies Compliance Tests

8.1.2.5. Differential-to-Common-Mode Conversion Limit

If all measurement points from 100 MHz to 7.5 GHz ≤ -20 dB: Pass, else: Fail.

8.1.3. Measurement Result Example

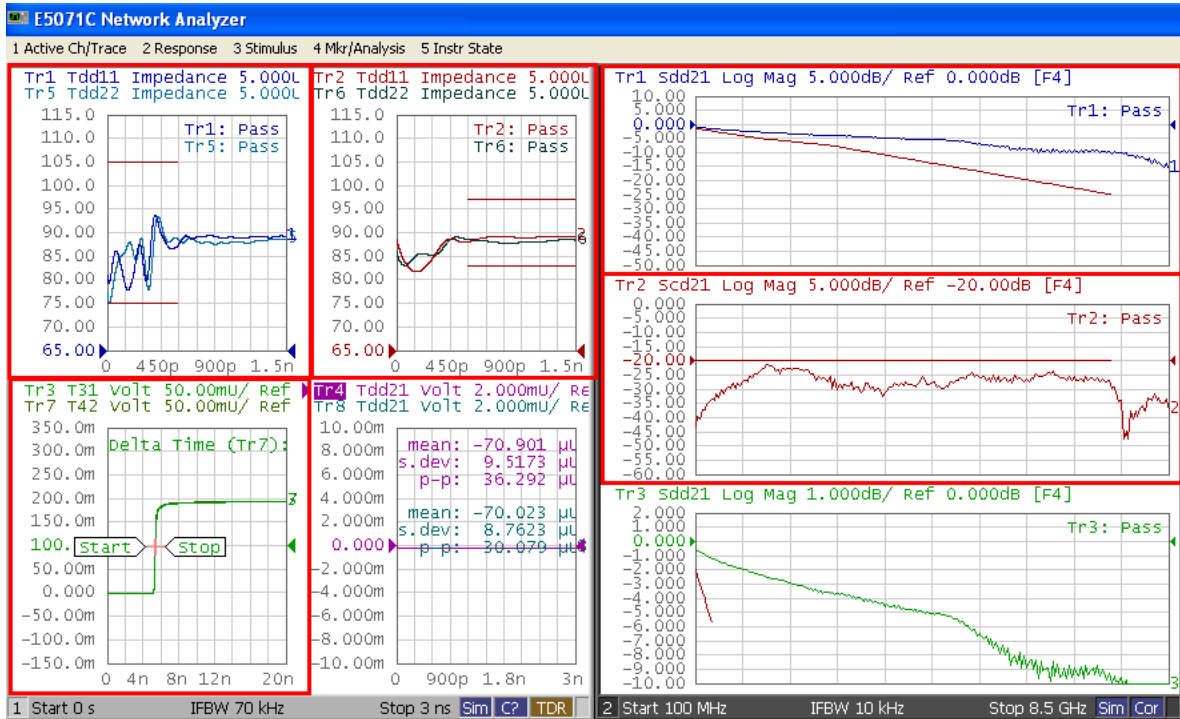

Agilent MOI for USB 3.0 Connectors & Cable Assemblies Compliance Tests

8.2. Near End Crosstalk

8.2.1. Measurement

1. Connect USB 3.0 official test fixtures to the test port cables according to the Table 8-2 Near End Crosstalk Connection. Unused terminals should be terminated.
2. Connect an USB 3.0 Cable to the test fixtures.
3. Click **Stop Single**.
4. Read the peak-to-peak (p-p) value.
5. Using the same manner above, measure the other pair.

Table 8-2 Near End Crosstalk Connection

	Standard-A to Standard-B				Standard-A to Micro-AB				Standard-A to Standard-A			
ENA Port#	Port1	Port2	Port3	Port4	Port1	Port2	Port3	Port4	Port1	Port2	Port3	Port4
PIN #	X8	X9	X5	X6	X8	X9	X5	X6	X8	X9	X5	X6
	Y5	Y6	Y8	Y9	Y6	Y7	Y9	Y10	Y8	Y9	Y5	Y6
	Micro-AB to Micro-AB				Micro-AB to Standard-B							
ENA Port#	Port1	Port2	Port3	Port4	Port1	Port2	Port3	Port4				
PIN #	X6	X7	X9	X10	X6	X7	X9	X10				
	Y6	Y7	Y9	Y10	Y5	Y6	Y8	Y9				

8.2.2. Data Analysis

Standard-A	If p-p <= 3.6 mV: Pass, else: Fail
Standard-B	If p-p <= 7.2 mV: Pass, else: Fail
Micro-AB	If p-p <= 4.8 mV: Pass, else: Fail

Agilent MOI for USB 3.0 Connectors & Cable Assemblies Compliance Tests

8.2.3. Measurement Result Example

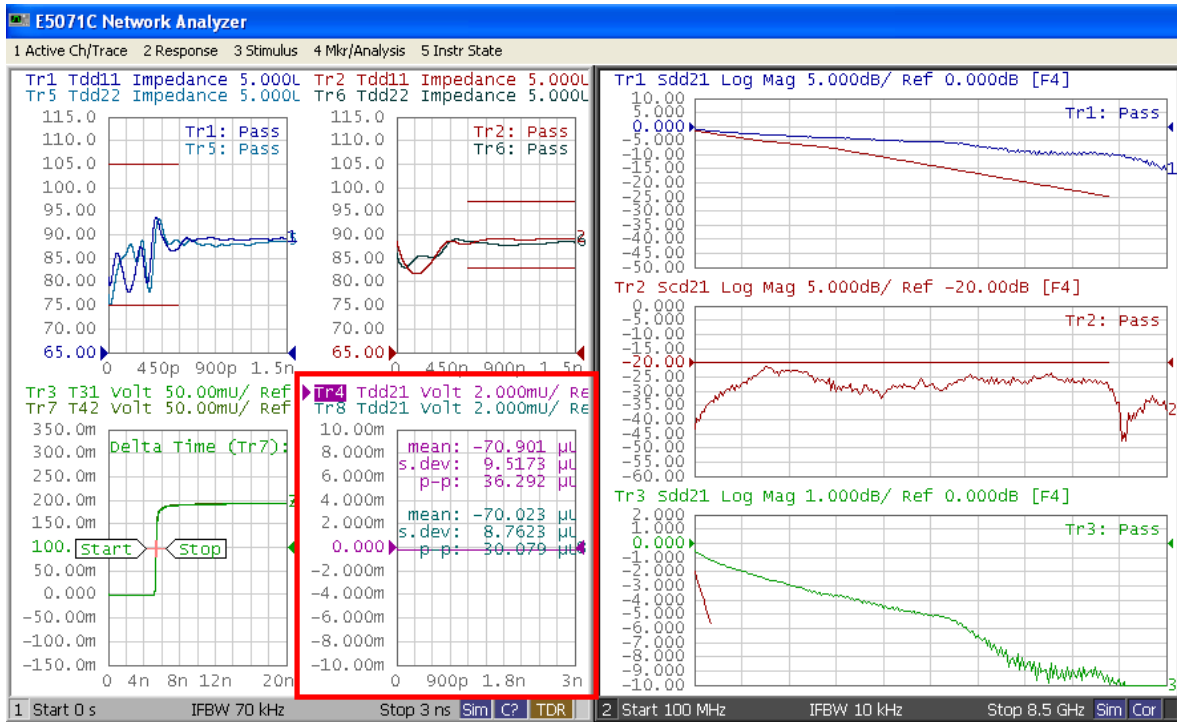

Agilent MOI for USB 3.0 Connectors & Cable Assemblies Compliance Tests

8.3. Crosstalk Between D+/D- and Super Speed

8.3.1. Measurement

1. Connect USB 3.0 official test fixtures to the test port cables according to the Table 8-3 Crosstalk Between D+/D- and Supper Speed Connection. Unused terminals should be terminated.
2. Connect an USB 3.0 Cable to the test fixtures.
3. Click **Stop Single**.
4. Read the peak-to-peak (p-p) value.
5. Using the same manner above, measure other pairs.

Agilent MOI for USB 3.0 Connectors & Cable Assemblies Compliance Tests

Table 8-3 Crosstalk Between D+/D- and Supper Speed Connection

	Standard-A to Standard-B				Standard-A to Micro-AB				Standard-A to Standard-A			
ENA Port#	Port1	Port2	Port3	Port4	Port1	Port2	Port3	Port4	Port1	Port2	Port3	Port4
PIN #	X2	X3	X5	X6	X2	X3	X5	X6	X2	X3	X5	X6
	X2	X3	X8	X9	X2	X3	X8	X9	X2	X3	X8	X9
	X2	X3	Y5	Y6	X2	X3	Y6	Y7	X2	X3	Y5	Y6
	X2	X3	Y8	Y9	X2	X3	Y9	Y10	X2	X3	Y8	Y9
	X5	X6	Y2	Y3	X5	X6	Y2	Y3	X5	X6	Y2	Y3
	X8	X9	Y2	Y3	X8	X9	Y2	Y3	X8	X9	Y2	Y3
	Y5	Y6	Y2	Y3	Y6	Y7	Y2	Y3	Y5	Y6	Y2	Y3
	Y8	Y9	Y2	Y3	Y9	Y10	Y2	Y3	Y8	Y9	Y2	Y3
	Micro-AB to Micro-AB				Micro-AB to Standard-B							
ENA Port#	Port1	Port2	Port3	Port4	Port1	Port2	Port3	Port4				
PIN #	X2	X3	X6	X7	X2	X3	X6	X7				
	X2	X3	X9	X10	X2	X3	X9	X10				
	X2	X3	Y6	Y7	X2	X3	Y5	Y6				
	X2	X3	Y9	Y10	X2	X3	Y8	Y9				
	X6	X7	Y2	Y3	X6	X7	Y2	Y3				
	X9	X10	Y2	Y3	X9	X10	Y2	Y3				
	Y6	Y7	Y2	Y3	Y5	Y6	Y2	Y3				
	Y9	Y10	Y2	Y3	Y8	Y9	Y2	Y3				

Agilent MOI for USB 3.0 Connectors & Cable Assemblies Compliance Tests

8.3.2. Data Analysis

Standard-A	If p-p <= 8.0 mV: Pass, else: Fail
Standard-B	If p-p <= 8.0 mV: Pass, else: Fail
Micro-AB	If p-p <= 8.0 mV: Pass, else: Fail

8.3.3. Measurement Result Example



Agilent MOI for USB 3.0 Connectors & Cable Assemblies Compliance Tests

8.4. D+/D- Pair Propagation Delay, D+/D- Pair Intra-Pair Skew and D+/D- Pair Attenuation

8.4.1. Measurement

1. Connect USB 3.0 official test fixtures to the test port cables according to the Table 8-4 D+/D- Pair Propagation Delay, D+/D- Pair Intra-Pair Skew and D+/D- Pair Attenuation Connection
2. Connect an USB 3.0 cable to the test fixtures.
3. Click **Stop Single** for Time Domain measurements.
4. Press **Trigger > Single** for Frequency Domain measurements.

Table 8-4 D+/D- Pair Propagation Delay, D+/D- Pair Intra-Pair Skew and D+/D- Pair Attenuation Connection

	Standard-A to Standard-B				Standard-A to Micro-AB				Standard-A to Standard-A			
ENA Port#	Port1	Port2	Port3	Port4	Port1	Port2	Port3	Port4	Port1	Port2	Port3	Port4
PIN #	X2	X3	Y2	Y3	X2	X3	Y2	Y3	X2	X3	Y2	Y3
	Micro-AB to Micro-AB				Micro-AB to Standard-B							
ENA Port#	Port1	Port2	Port3	Port4	Port1	Port2	Port3	Port4				
PIN #	X2	X3	Y2	Y3	X2	X3	Y2	Y3				

Agilent MOI for USB 3.0 Connectors & Cable Assemblies Compliance Tests

8.4.2. Data Analysis

8.4.2.1. D+/D- Pair Propagation Delay

1. Select **Trace 3**.
2. Press **Trace Max** key on the instrument front panel to enlarge the trace.
3. Read Marker Value 1 on Trace 3.
4. Press **Trace Max** key on the instrument front panel to shrink the trace.

Standard-A to Standard-B	If the time at the rising edge < 26 nsec: Pass, else: Fail
Standard-A to Standard-A	
Standard-A to Micro-AB	If the time at the rising edge < 10 nsec: Pass, else: Fail
Micro-AB to Micro-AB	
Micro-AB to Standard-B	

8.4.2.2. D+/D- Pair Intra-Pair Skew

1. Select **Trace 3**.
2. Press **Trace Max** key on the instrument front panel to enlarge the trace.
3. Read the Delta Time.
4. Press **Trace Max** key on the instrument front panel to shrink the trace.

If Delta Time < 100 psec: Pass, else: Fail

8.4.2.3. D+/D- Pair Attenuation

Start Frequency	End Frequency	Start Limit	End Limit
12 MHz	24 MHz	-670 mdB	-950 mdB
24 MHz	48 MHz	-950 mdB	-1.35 dB
48 MHz	96 MHz	-1.35 dB	-1.9 dB
96 MHz	200 MHz	-1.9 dB	-3.2 dB
200 MHz	400 MHz	-3.2 dB	-5.8 dB

Agilent MOI for USB 3.0 Connectors & Cable Assemblies Compliance Tests

8.4.3. Measurement Result Example

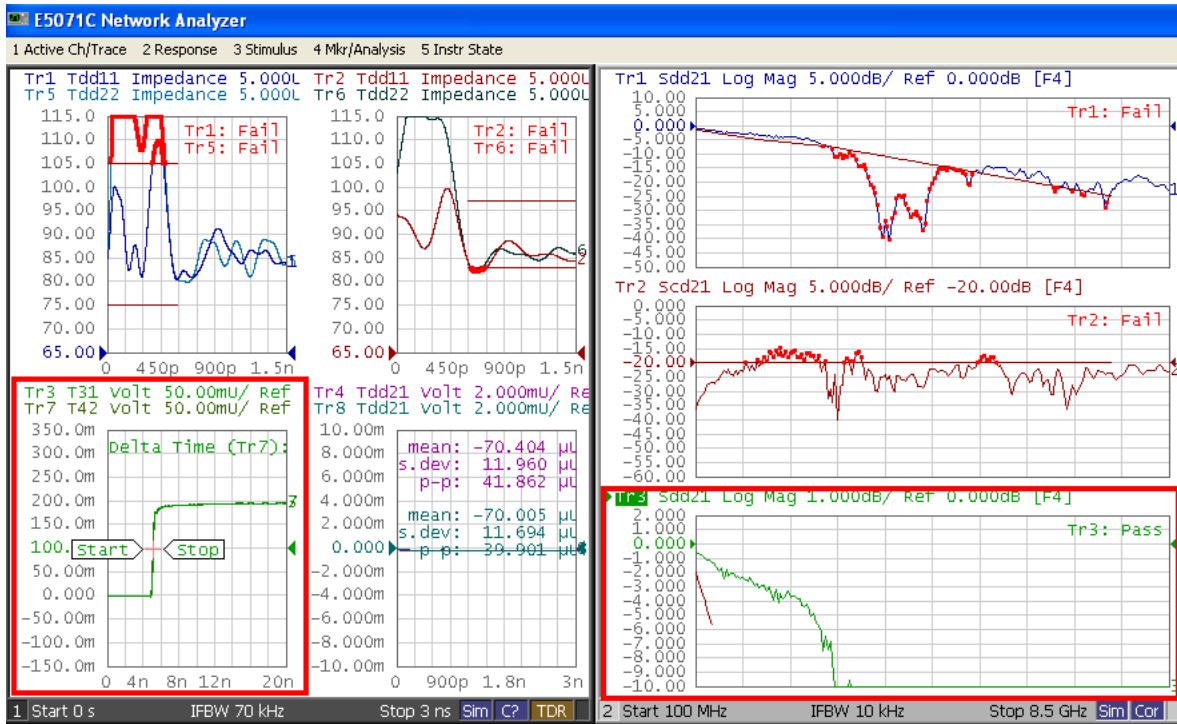

9. Appendix

9.1. Defining a calibration kit

To change the definition of a calibration kit, follow the procedure below.

1. Press **Cal** key on the instrument front panel.
2. Click **Cal Kit > User**
3. Click **Modify Kit > Label Kit [User]**, then type in a name you want.
4. Click **Define STDs >**
 - a) **1.No Name >**
 1. **Label** : "Thru"
 2. **STD Type** : Delay/Thru
 3. **Offset Delay** : Value defined by the fixture
 4. **Offset Z0** : Value defined by the fixture
 5. **Offset Loss** : Value defined by the fixture
 6. **Min. Frequency** : Value defined by the fixture
 7. **Max. Frequency** : Value defined by the fixture
 8. **Return**
 - b) **2.No Name >**
 1. **Label** : "Short"
 2. **STD Type** : Short
 3. **Offset Delay** : Value defined by the fixture
 4. **Offset Z0** : Value defined by the fixture
 5. **Offset Loss** : Value defined by the fixture
 6. **Min. Frequency** : Value defined by the fixture
 7. **Max. Frequency** : Value defined by the fixture
 8. **Return**
 - c) **3.No Name >**
 1. **Label** : "Open"
 2. **STD Type** : Open

Agilent MOI for USB 3.0 Connectors & Cable Assemblies Compliance Tests

3. **Offset Delay** : Value defined by the fixture
 4. **Offset Z0** : Value defined by the fixture
 5. **Offset Loss** : Value defined by the fixture
 6. **Min. Frequency** : Value defined by the fixture
 7. **Max. Frequency** : Value defined by the fixture
 8. **Return**
- d) **4.No Name** >
1. **Label** : "Load"
 2. **STD Type** : Load
 3. **Offset Delay** : Value defined by the fixture
 4. **Offset Z0** : Value defined by the fixture
 5. **Offset Loss** : Value defined by the fixture
 6. **Min. Frequency** : Value defined by the fixture
 7. **Max. Frequency** : Value defined by the fixture
 8. **Return**
- e) **5.No Name** >
1. **Label** : "Line1"
 2. **STD Type** : Delay/Thru
 3. **Offset Delay** : Value defined by the fixture
 4. **Offset Z0** : Value defined by the fixture
 5. **Offset Loss** : Value defined by the fixture
 6. **Min. Frequency** : Value defined by the fixture
 7. **Max. Frequency** : Value defined by the fixture
 8. **Return**
- f) **6.No Name** >
1. **Label** : "Line2"
 2. **STD Type** : Delay/Thru
 3. **Offset Delay** : Value defined by the fixture

Agilent MOI for USB 3.0 Connectors & Cable Assemblies Compliance Tests

4. **Offset Z0** : Value defined by the fixture
 5. **Offset Loss** : Value defined by the fixture
 6. **Min. Frequency** : Value defined by the fixture
 7. **Max. Frequency** : Value defined by the fixture
 8. **Return**
- g) **7.No Name** >
1. **Label** : "Line3"
 2. **STD Type** : Delay/Thru
 3. **Offset Delay** : Value defined by the fixture
 4. **Offset Z0** : Value defined by the fixture
 5. **Offset Loss** : Value defined by the fixture
 6. **Min. Frequency** : Value defined by the fixture
 7. **Max. Frequency** : Value defined by the fixture
 8. **Return**
5. Click **Return**.
6. Click **Specify CLSs** >
- h) **Sub class1** >
1. **TRL Thru** > **Set All** > **Thru** > **Return**
 2. **TRL Reflect** > **Short** or **Open**
 3. **TRL Line/Match** > **Set All** > **Line1** > **Return**
- i) **Sub class2** >
4. **TRL Line/Match** > **Set All** > **Line2** > **Return**
- j) **Sub class3** >
5. **TRL Line/Match** > **Set All** > **Line3** > **Return**
7. Click **Return**
8. Click **Export Calkit...** to open the dialog box and Save user Calkit.
9. Specify a folder, enter a file name, and click **Save**.

Note: Refer to "Modifying Calibration Kit Definition" in ENA online help for the detail.

Agilent MOI for USB 3.0 Connectors & Cable Assemblies Compliance Tests

9.2. Time domain Measurement Setup Manually

9.2.1. Starting Setup

1. If TDR setup wizard appears, click **Close** button in the TDR setup wizard.
2. Click **Setup** tab (item 1).
3. Click **Preset** (item 2) under Basic to preset the E5071C.
4. A dialog box appears requesting for confirmation. Then click **OK**.
5. Select **DUT Topology** (item 3) to Differential 2-port.
6. Click **Advanced Mode** (item 4).

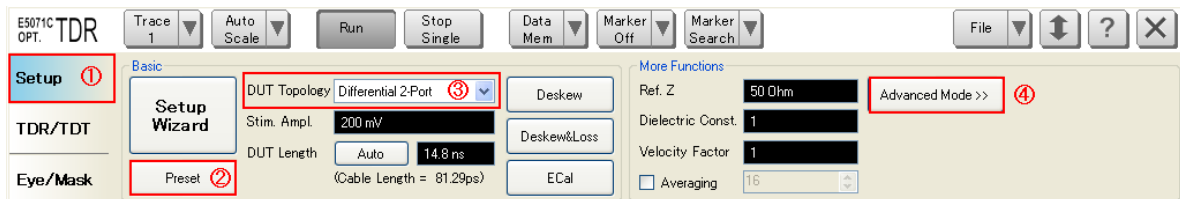

7. A dialog box appears requesting for confirmation. Then click **Yes**. (Clear the check box for “Use Advanced Calibration Methods”)

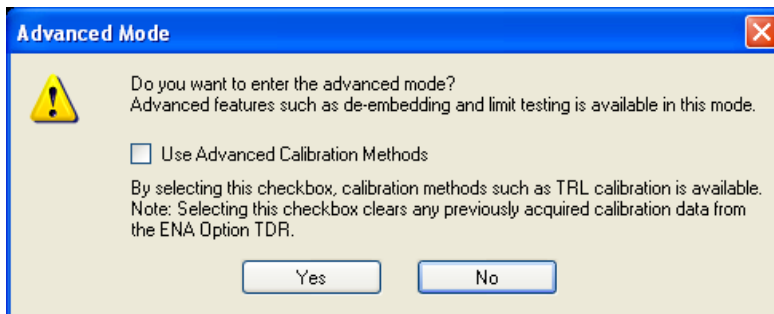

Agilent MOI for USB 3.0 Connectors & Cable Assemblies Compliance Tests

9.2.2. Mated Connector Impedance Measurements (Normative)

9.2.2.1. Impedance Profile

The impedance profile of the mated connector is defined from the receptacle through the plug cable mated area.

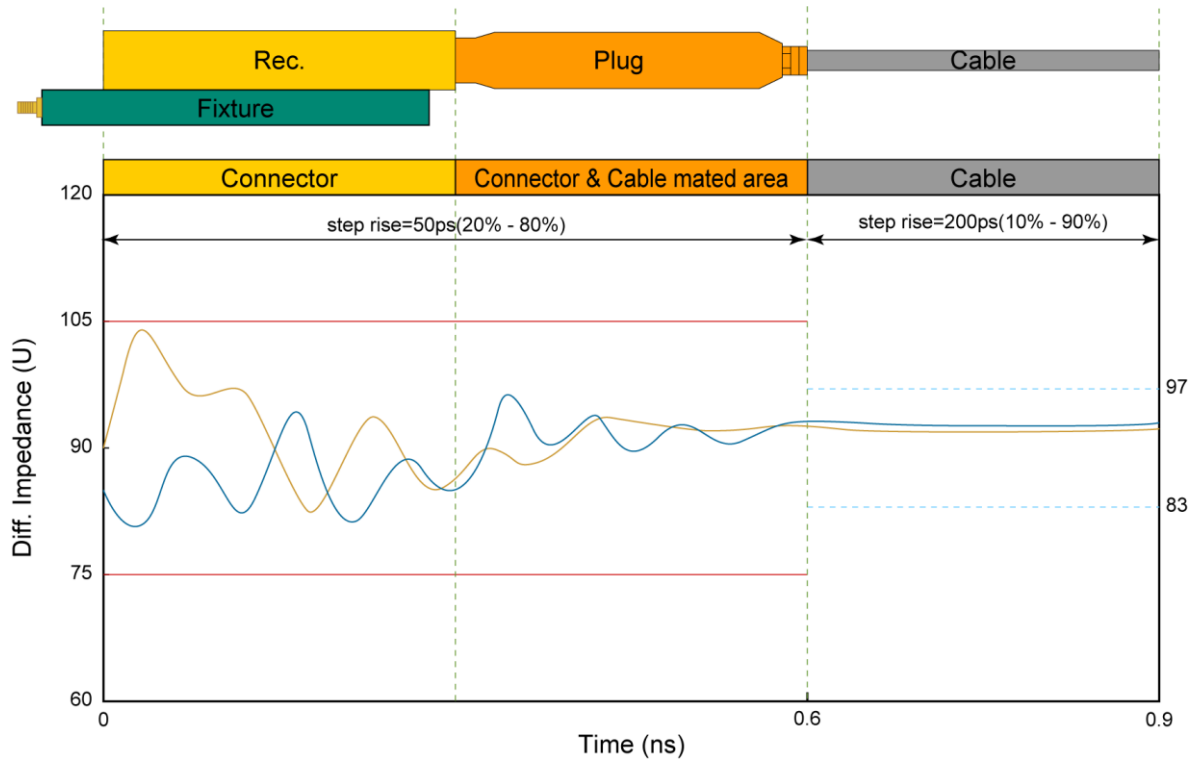

9.2.2.2. Measurement Setup

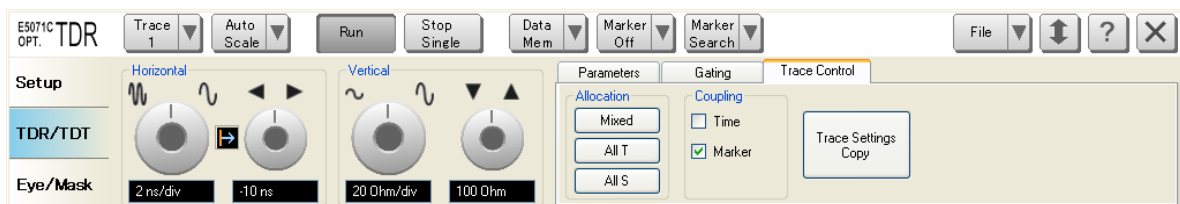

1. Click **Stop Single**.
2. Click **TDR/TDT** tab.
3. Click **Trace Control** tab.
4. Clear **Time** check box under Coupling.
5. Clear **Marker** check box under Coupling

Agilent MOI for USB 3.0 Connectors & Cable Assemblies Compliance Tests

6. Click **Parameters** tab.
7. Select **Trace 1**.
8. Select **Rise Time** to 20-80 % and input value to 50 psec.
9. Click the box below the left knob under Horizontal. Then Entry dialog box appears.
10. Input horizontal scale to 150 psec/div.
11. Click the box below the right knob under Horizontal. Then Entry dialog box appears.
12. Input horizontal position to 0 sec.
13. Click the box below the left knob under Vertical. Then Entry dialog box appears.
14. Input vertical scale to 5 ohm/div.
15. Click the box below the right knob under Vertical. Then Entry dialog box appears.
16. Input vertical position to 65 ohm.
17. Click **Trace Control** tab.
18. Click **Trace Settings Copy**.
19. Trace Settings Copy dialog box appears.
20. Select the **Trace 1** in the From list.
21. Select the **Trace 5** in the To list.
22. Click **Copy**.
23. Click **Close**.
24. Select **Trace 5**.
25. Click **Parameters** tab.
26. Click **Tdd22**.

Agilent MOI for USB 3.0 Connectors & Cable Assemblies Compliance Tests

9.2.3. Raw Cable Impedance Measurements (Informative)

9.2.3.1. Impedance Profile

Refer to 9.2.2.1 Impedance Profile

9.2.3.2. Measurement Setup

1. Click **Trace Control** tab.
2. Click **Trace Settings Copy**.
3. Trace Settings Copy dialog box appears.
4. Select the **Trace 1** in the From list.
5. Select the **Trace 2** in the To list.
6. Click **Copy**.
7. Click **Close**.
8. Select **Trace 2**.
9. Click **Parameters** tab.
10. Select **Rise Time** to 10-90 % and input value to 200 psec.
11. Click **Trace Control** tab.
12. Click **Trace Settings Copy**.
13. Trace Settings Copy dialog box appears.
14. Select the **Trace 2** in the From list.
15. Select the **Trace 6** in the To list.
16. Click **Copy**.
17. Click **Close**.
18. Select **Trace 6**.
19. Click **Parameters** tab.
20. Click **Tdd22**.

Agilent MOI for USB 3.0 Connectors & Cable Assemblies Compliance Tests

9.2.4. Propagation Delay and Intra-Pair Skew Measurement (Informative)

9.2.4.1. Measurement Setup

1. Select **Trace 3**.
2. Click **Parameters** tab.
3. Select the **Topology** (item1) of DUT to Single-Ended.

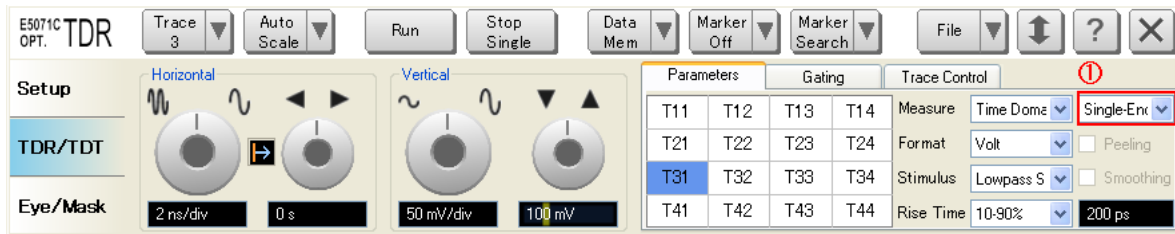

4. Select **Format** to Volt.
5. Click **T31**.
6. Select **Rise Time** to 10-90 % and input value to 200 psec.
7. Click the box below the left knob under Horizontal. Then Entry dialog box appears.
8. Input horizontal scale to 3 ns/div.
9. Click the box below the right knob under Horizontal. Then Entry dialog box appears.
10. Input horizontal position to 0 ns.
11. Click the box below the left knob under Vertical. Then Entry dialog box appears.
12. Input vertical scale to 50 mV/div.
13. Click the box below the right knob under Vertical. Then Entry dialog box appears.
14. Input vertical position to 100 mV.
15. Click **Trace Control** tab.
16. Click **Trace Settings Copy**.
17. Trace Settings Copy dialog box appears.
18. Select the **Trace 3** in the From list.
19. Select the **Trace 7** in the To list.
20. Click **Copy**.
21. Click **Close**.

Agilent MOI for USB 3.0 Connectors & Cable Assemblies Compliance Tests

22. Select **Trace 7**.
23. Click **Parameters** tab.
24. Click **T42**.
25. Select **Trace 3**.
26. Click **Marker Search** and select **Δ Time**.
27. Delta Time dialog box appear.
28. Check the **Δ Time** check box.
29. Select **Target (Stop)** to Trace 7.
30. Click **OK**.
31. Click **Marker Search** > **Target** > **Target Value**, and enter 100 mU.
32. Turn **Tracking** on.

9.2.4.2. Crosstalk Compensation

1. Select **Trace 3**.
2. Press **Display** > **Equation Editor...** > Enter an equation "**Intra+= S31-S32**".
3. Check **Equation Enabled** check box.
4. Click **Apply**.
5. Click **Close**.
6. Select **Trace 7**.
7. Press **Display** > **Equation Editor...** > Enter an equation "**Intra-= S42-S41**".
8. Check **Equation Enabled** check box.
9. Click **Apply**.
10. Click **Close**.

Agilent MOI for USB 3.0 Connectors & Cable Assemblies Compliance Tests

9.2.5. Differential Near End Crosstalk Measurements (Normative)

9.2.5.1. Measurement Setup

1. Select **Trace 4**.
2. Click **Parameters** tab.
3. Select **Measurement** to Time Domain.
4. Select **Format** to Volt.
5. Select **Rise Time** to 20-80% and input value to 50 psec.
6. Click **Tdd21**.
7. Click the box below the left knob under Horizontal. Then Entry dialog box appears.
8. Input horizontal scale to 300 ps/div.
9. Click the box below the right knob under Horizontal. Then Entry dialog box appears.
10. Input horizontal position to 0 s.
11. Click the box below the left knob under Vertical. Then Entry dialog box appears.
12. Input vertical scale to 2 mV/div.
13. Click the below the right knob under vertical. Then Entry dialog box appears.
14. Input vertical scale to 0 V.
15. Press **Marker Fctn** > **Statistics** and turn it **ON**.

Agilent MOI for USB 3.0 Connectors & Cable Assemblies Compliance Tests



9.2.6. Differential Crosstalk between D+/D- and Super Speed Measurements (Normative)

1. Click **Trace Control** tab.
2. Click **Trace Settings Copy**.
3. Trace Settings Copy dialog box appears.
4. Select the **Trace 4** in the From list.
5. Select the **Trace 8** in the To list.
6. Click **Copy**.
7. Click **Close**.
8. Select **Trace 8**.
9. Click **Parameters** tab.
10. Select **Rise Time** to 10-90% and input value to 500 psec.
11. Press **Marker Fctn** > **Statistics** and turn it **ON**.

Agilent MOI for USB 3.0 Connectors & Cable Assemblies Compliance Tests

9.3. Frequency Domain Measurement Setup Manually

9.3.1. Channel and Trace Settings

1. Press **Display** key on the instrument front panel.
2. Click **Allocate Channels** > .
3. Press **Channel Next** key on the instrument front panel.
4. Click **Num of Traces** > **3**.
5. Click **Allocate Traces** > .

9.3.2. Common Settings

1. Press **Sweep Setup** > **Sweep Type** > **Lin Freq**.
2. Set **Points** to 201.
3. Press **Start** > Set start value to 100 MHz.
4. Press **Stop** > Set stop value to 8.5 GHz.
5. Press **Avg** > Set **IF Bandwidth** to 10 kHz.
6. Press **Analysis** > **Fixture Simulator** > **Fixture Simulator** and turn it **ON**.
7. Click **Port ZConversion** and turn it **ON**.
8. Set **Port1 Z0 Real**, **Port2 Z0 Real**, **Port3 Z0 Real** and **Port4 Z0 Real** to 45 ohm.
9. Click **Return**.

9.3.3. Insertion Loss Measurements (Normative)

1. Select Trace1.
2. Click **Topology** > **Device** > **Bal-Bal**.
3. Click **Port1 (bal)** > **1-2**.
4. Click **Port2 (bal)** > **3-4**.
5. Click **Return**.
6. Click **BalUn** and turn it **ON**.
7. Click **Measurement** > **Sdd21**.
8. Press **Scale** > Set **Divisions** to 12.

Agilent MOI for USB 3.0 Connectors & Cable Assemblies Compliance Tests

9. Set **Scale/Div** to 5 dB/div.
10. Set **Reference position** to 10 Div.
11. Set **Reference Value** to 0 dB.

9.3.4. Differential-to-Common-Mode Conversion Measurements (Normative)

1. Press **Trace Next** key on the instrument front panel.
2. Press **Analysis** key on the instrument front panel.
3. Click **Fixture Simulator** > **BalUn** and turn it **ON**.
4. Click **Measurement** > **Scd21**.
5. Press **Scale** > Set **Divisions** to 12.
6. Set **Scale/Div** to 5 dB/div.
7. Set **Reference position** to 8 Div.
8. Set **Reference Value** to -20 dB.

9.3.5. D+/D- Pair Attenuation Measurements (Normative)

1. Press **Trace Next** key on the instrument front panel.
2. Press **Analysis** key on the instrument front panel.
3. Click **Fixture Simulator** > **BalUn** and turn it **ON**.
4. Click **Measurement** > **Sdd21**.
5. Press **Scale** > Set **Divisions** to 12.
6. Set **Scale/Div** to 1 dB/div.
7. Set **Reference position** to 10 Div.
8. Set **Reference Value** to 0 dB.

Agilent MOI for USB 3.0 Connectors & Cable Assemblies Compliance Tests

9.4. Limit Settings

9.4.1. Displaying Judgment Result of Test

If a channel has a judgment result of fail, the fail message appears on the screen. It will be judged as failed if one or more unsatisfactory trace exists within the channel.

Follow the procedure below.

1. Press **Analysis** > **Limit Test** > **Fail Sign** to switch the fail sign ON/OFF.

9.4.2. Setting the Warning Beeper

Beep sound that occurs when the judgment result is fail.

Follow the procedure below.

1. Press **System** > **Misc Setup** > **Beeper** > **Beeper Warning** to switch the warning beeper ON/OFF.

9.4.3. Defining the Limit Line

Follow the steps below to make entries in the limit table for trace 1 of Time Domain Measurement.

1. Press **Channel Next** key on the instrument front panel to select channel 1.
2. Select trace 1.
3. Press **Analysis** > **Limit Test** > **Edit Limit Line** to display the limit table shown below (Initially, no segments are entered in the limit table). Using the limit table, create/edit a segment.
4. Enter the setup data in the limit table for trace 1.

	Type	Begin Stimulus	End Stimulus	Begin Response	End Response
1	MAX	0 s	600 ps	105 U	105 U
2	MIN	0 s	600 ps	75 U	75 U
3	▼				

Agilent MOI for USB 3.0 Connectors & Cable Assemblies Compliance Tests

Segment Parameter	Description
Type	MIN: Segment at which the minimum is specified MAX: Segment at which the maximum is specified
Begin Stimulus	Specify starting point for stimulus value on the limit line
End Stimulus	Specify ending point for stimulus value on the limit line
Begin Response	Specify starting point for response value on the limit line
End Response	Specify ending point for response value on the limit line

5. Click **Return**.
6. Click **Limit Line** and turn it **ON**.
7. Click **Limit Test** and turn it **ON**.